

TENDA GROUP LIMITED

Add:1st Building ,Zhuowei Industrial Park,
 1st Dahua Road,Xinhua Town ,Huadu District ,Guangzhou , China
 Tel:0086-20-22100510 Email: tendasolutions@gmail.com Web:www.tendaelectronics.com

Price List

Date:20th Jan. ,2011

Following price in USD base on Ex-works terms , Valid within Feb.,2011 ,Pls reconfirm price before issue P/O

MP3 Player Modules				EX-Works Price in USD		
Products	Part No.	Reference Picture	Descriptions	Unit Price	Quantity	Sample Price
MP3 Module	TD396FL		1.Support MP3 / WMA format	US dollar	PCS	\$8.00
			2.Support USB / SD /AUX / FM / Remote (AUX,FM,Remote Optional)	\$4.80	500	
			3.With LED display , stereo audio output ,16Bit DAC	\$4.50	1000	
			4.Round or Rectangular Pannel optional	\$4.40	2000	
			5.Black / Silver / Blue color sticker optional			
			6.With functions Play/Pause , Next,Prev,Vol-,Vol+ , Mode selection on Pannel key board	\$4.20	3000	
			7.Power input DC 5 V / 12V Versions			

MP3 Module	TDK896		1.USB/SD/AUX/FM /Remote ((FM , Remote Optional))			\$8.00
			2.Support MP3 and WAV format			
			3.Stereo audio output ,18Bit DAC	\$4.70	500	
			4.Play/pause, next,prev. ,repeat,vol,EQ,stop,mute,power off	\$4.50	1000	
			5.Memory song and volume level after power off	\$4.30	2000	
			6.Date , Time ,Alarm , LED display			
			7.On-board 3 watts amplifier optional Black or silver pannel stickers opional	\$4.10	3000	
			8.Power input DC 3.7 V / 5V Versions			
MP3 Module	TDK903		1.USB/SD/AUX/FM /Remote ((FM , Remote Optional))			\$8.00
			2.Support MP3 and WAV format			
			3.Stereo audio output ,18Bit DAC	\$4.70	500	
			4.Play/pause, next,prev. ,repeat,vol,EQ,stop,mute,power off	\$4.50	1000	
			5.Memory song and volume level after power off	\$4.30	2000	
			6.Date , Time ,Alarm , LED display			
			7.On-board 3 watts amplifier optional Black pannel sticker	\$4.10	3000	
			8.Power input DC 3.7 V / 5V Versions			

MP3 Module	TDK866		1.USB/SD/AUX/FM /Remote ((FM , Remote Optional))			\$9.00
			2.Support MP3 and WAV format			
			3.Stereo audio output ,18Bit DAC	\$5.50	500	
			4.Play/pause, next,prev. ,repeat,vol,EQ,stop,mute,power off			
			5.Memory song and volume level after power off	\$5.30	1000	
			6.Date , Time ,Alarm , LCD display	\$5.10	2000	
			7.On-board 3 watts amplifier optional	\$4.90	3000	
			8.Power input DC 3.7 V / 5V Versions			
MP3 Module	TDK898		1.USB/SD/AUX/FM /Remote ((FM , Remote Optional))			\$8.00
			2.Support MP3 and WAV format	\$4.40	500	
			3.Stereo audio output ,18Bit DAC	\$4.10	1000	
			4.Play/pause, next,prev. ,repeat,vol,EQ,stop,mute,power off			
			5.Memory song and volume level after power off	\$3.90	2000	
			6.On-board 3 watts amplifier			
			7.On/ Off power switch	\$3.70	3000	
			8.Power input DC 3.7 V / 5V Versions			

MP3 Module	TDK868		1.USB/SD/AUX/FM /Remote (FM , Remote Optional)			\$8.00
			2.Support MP3 and WAV format	\$4.40	500	
			3.Stereo audio output , 18Bit DAC	\$4.10	1000	
			4.Play/pause, next,prev. ,repeat,vol,EQ,stop,mute,power off			
			5.Memory song and volume level after power off	\$3.90	2000	
			6.On-board 3 watts amplifier optional			
			7.Four color pannels optional	\$3.70	3000	
			8.Power input DC 3.7 V / 5V Versions			

MP3 Module	TDK838		1.USB/SD/FM/ Remte (FM , remote optional)	\$3.80	500	\$8.00
			2.Support MP3 and WAV format	\$3.50	1000	
			3.Stereo audio output ,18Bit DAC			
			4.Play/pause, next,prev. ,repeat,vol,EQ,stop,mute,power off	\$3.30	2000	
			5.Memory song and volume level after power off			
			6.Sliver and Black sticker optional	\$3.10	3000	
			7.Power input DC 3.7 V / 5V Versions			

MP3 Module	TDK009		1.USB/SD/ Remte (remote optional)			\$8.00
			2.Support MP3 and WAV format	\$4.40	500	
			3.Stereo audio output ,18Bit DAC	\$4.10	1000	
			4.Play/pause, next/Vol+ ,prev. /Vol- ,repeat,EQ,stop,mute,power off			
			5.Memory song and volume level after power off	\$3.90	2000	
			6.On-board 3 watts amplifier optional			
			7.Black color pannel sticker	\$3.70	3000	
			8.Power input DC 3.7 V / 5V Versions			

MP3 Module	TDK178	 <p>MP3 Player + Remote + Connector</p>	1.USB/SD/ FM /Remte (FM,remote optional)			\$8.00
			2.Support MP3 and WAV format	\$4.40	500	
			3.Stereo audio output ,18Bit DAC	\$4.10	1000	
			4.Play/pause, next/Vol+ ,prev. /Vol- ,repeat,EQ,stop,mute,power off			
			5.Memory song and volume level after power off	\$3.90	2000	
			6.On-board 3 watts amplifier optional			
			7.Standard Power input DC 3.7 V , Support DC 5V with Power Connector	\$3.70	3000	

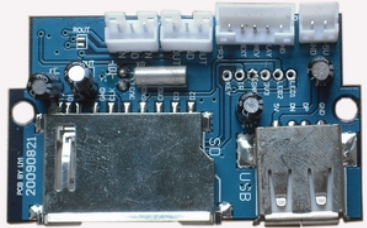
MP3 Module	TDKHU8		1.DC 5V power ,stereo audio output			\$5.00
			2.Support mp3 audio files playing			
			3.SD card ,USB memory supported upto16GB	\$2.80	1000	
			4.Start playing once power on,	\$2.60	2000	
			5.With play/pause,next / vol+ ,previous/ vol-,funtions	\$2.40	3000	
			6.Connectors for external pushbuttons , Power , Audio output			

MP3 Module	TDKHU3		1.DC 5V power ,stereo audio output			\$5.00
			2.Support mp3 audio files playing	\$2.80	1000	
			3.SD card ,USB memory supported upto16GB	\$2.60	2000	
			4.Start playing once power on,	\$2.40	3000	
			5.With play/pause,next / vol+ ,previous/ vol-,funtions			
			6.Connectors for external pushbuttons , Power , Audio output			

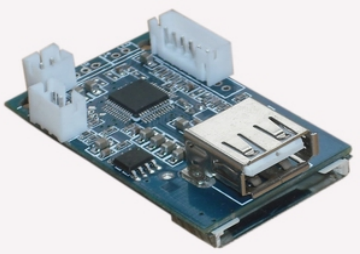
MP3 Module	TDKU208		1.DC 5V power ,stereo audio output			\$5.00
			2.Support mp3 audio files playing	\$2.80	1000	
			3.SD card ,USB memory supported upto16GB	\$2.60	2000	
			4.Start playing once power on,	\$2.40	3000	
			5.With play/pause,next,previous,vol-,vol+ ,funtions			
			6.Connectors for exteral pushbuttons , Power , Audio output			

Embedded MP3 Modules						
Embedded MP3 Module	TDB380		1.With serial interface for MCU control and keyboard interface for Pushbutton	\$6.20	100	\$10.00
			2.Play mp3 files in SD card. Easy to update the files by normal SD card reader .	\$5.80	200	
			3.DC5V--DC30V power input .	\$5.50	300	
			4.Cost effective than similar products	\$5.30	500	
			5.Support SD card up to 8GB	\$5.10	1000	
			6.With perfect stereo audio output			
			7. 1.27mm pitch pins			

Embedded MP3 Module	TDB380 +SDC08		1.With serial interface for MCU control and keyboard interface for Pushbutton	\$7.00	100	\$12.00
			2.Play mp3 files in SD card or USB drive Easy to update the files by PC	\$6.80	200	
			3.DC5V--DC30V power input .	\$6.50	300	
			4.Cost effective than similar products	\$6.30	500	
			5.Support SD and USB drive up to 8GB	\$6.00	1000	
			6.With perfect stereo audio output			
			7. SDC08 USB board optional			

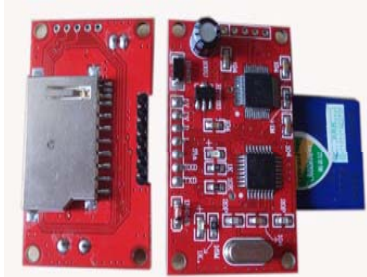
Embedded MP3 Module	TDS055		1.With serial interface for MCU control and keyboard interface for Pushbutton			\$13.00
			2.Play mp3 files in SD card. Easy to update the files by normal SD card reader .	\$10.00	100	
			3.Support background music in specify folder	\$9.50	200	
			4. MP3 decoder : VS1003B form VSLI	\$9.00	300	
			5.With perfect stereo audio output	\$8.50	500	
			6. Stable performance capable for industrial applications			
			7.Support upto 2GB SD card (FAT format)			

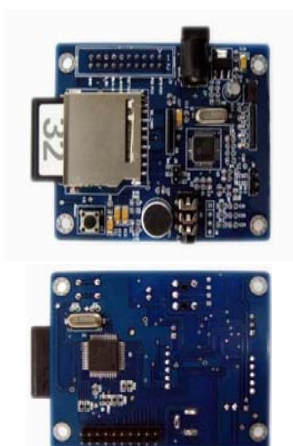
Embedded MP3 Module	TDR025		1. Support MP3 ,WMA, WAV ,MIDI			\$17.00
			2.Record / Play WAV to memory card	\$16.00	50	
			3.Decoder VS1003B from VSLI	\$15.00	100	
			4. Support MCU control via Serial port and Keys control	\$14.00	200	
			5. Stereo audio output , On-Board Microphone	\$13.00	300	
			6.DC3.7V to 9.1 V power input	\$12.50	500	

Video Player Modules

MP4 Module	TDA4B4		1.Support RM,RMVB,MP4,3GP,AVI, DIVX,VOB,DAT,JPEG, WMA, MP3 ,ACC	\$7.20	200	\$12.00
			2.Support SD /MMC/ MS and USB memory			
			3.With key board pannel and plastic sticker	\$6.90	500	
			4.With good quality stereo audio output and VGA also CVBS Video output			
			5. With remote function	\$6.60	1000	
			6.With functions Play/Pause , Next,Prev,Vol-,Vol+ , Mode selection on Pannel key board			
			7.DC 5 v power			

MP4 Module	TDK966	 	1.Support DVD、SVCD、VCD、DVCD、DVIX、MPEG4 ,AVI, VOB,MP3,WMA,HDCD	\$7.00	200	\$12.00
			2.Support SD /MMC/ USB drive /USB hard disk			
			3.With key board pannel and plastic sticker	\$6.80	500	
			4.With good quality stereo audio output also CVBS and VGA (Optional) video output			
			5. With remote function	\$6.50	1000	
			6.With functions Play/Pause , Next,Prev,Vol-,Vol+ , on Pannel key board			
			7.DC 5 v power			
MP5 Module	966R	 	1.Support RM, RMVB, DVD、SVCD、VCD、DVCD、DVIX、MPEG4 ,AVI, VOB,MP3,WMA,HDCD	\$9.50	200	\$15.00
			2.Support SD /MMC/ USB drive /USB hard disk			
			3.With key board pannel and plastic sticker	\$9.20	500	
			4.With good quality stereo audio output also CVBS and VGA (Optional) video output			
			5. With remote function	\$9.00	1000	
			6.With functions Play/Pause , Next,Prev,Vol-,Vol+ , on Pannel key board			
			7.DC 5 v power			

MP5 Module	TDA5B5		1.Support MP4,3GP,AVI, DIVX,VOB,DAT,JPEG, WMA, MP3 ,ACC	\$10.00	200	\$15.00
			2.Support SD /MMC/ MS and USB memory			
			3.With key board pannel and plastic sticker	\$9.70	500	
			4.With good quality stereo audio output and VGA also CVBS Video output			
			5. With remote function	\$9.40	1000	
			6.With functions Play/Pause , Next,Prev,Vol-,Vol+ , Mode selection on Pannel key board			
			7.DC 5 v power			

Amplifier Modules						
Amplifier Module	TDA25W		1.Amplifier Module	\$4.50	100	\$7.00
			2.Apply TI Class D amplifier IC			
			3.Low heating	\$4.30	300	
			4.25Watts X 2 output			
			5.Compact size	\$4.10	500	
			6.Short circuit protection	\$3.90	1000	

Amplifier Module	TDA03W		1.3 Watts * 2 output amplifier Module	\$1.20	300	\$4.00
			2.DC 3.7V and DC 5V and USB port power input options	\$1.10	500	
			3. Cost effective solution			
			4.On/Off switch	\$0.90	1000	
			5.Compact size			
			6.Power indicator	\$0.80	3000	
			7. Black plastic pannel			

Telephone Recorder						
Phone Recorder	TDK268		1. Record phone conversation automatically	\$20.00	100	\$25.00
			2.Recorded file save in SD/MMC card			
			3.The recorded file named by data and time	\$18.00	300	
			4.With Clock function			
			5.Support mp3 music files playback	\$16.00	500	
			6.LCD display			
			7.Built in Speaker	\$15.00	1000	
			8.Compact size			
			9. DC 5V power adaptor (110V or 220V)			

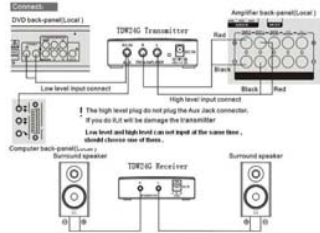
Wireless Audio transmitter and receiver			
Wireless Audio transceiver	TDW24G		1. Transmitter DC 5V power input
			2. Receiver DC 12V power input
			3. With AUX input, L & R channel input
			4. 3 Watts two channel output from receiver
			5. 50 Meters transmit distance (Open area)
			6. Volume control
			

	Red : Normaly MP3 player Modules
	Yellow: Embedded MP3 Modules
	Blue: Video Player Modules
	Green: Amplifier Modules
	Orange: Wireless Audio transceiver

Contact information

Fatroy add: 1st Building ,Zhuowei Industrial Park,Dahua 1st Road,Xinhua Town ,Huadu District ,Guangzhou , China

Tel:0086-20-22100510

Web: www.tendaelectronics.com

Email: tendaelectronics@gmail.com Email : tendasolutions@gmail.com

MSN: keithfoun@hotmail.com

MSN : tendasolutions@hotmail.com